

P/N: FALCH0805-392K

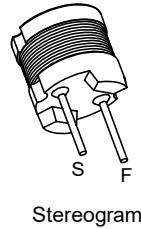

Outline Dimensions(Unit:mm)

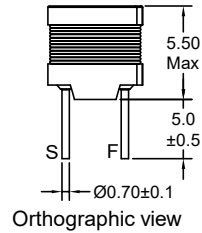

Material list

Part Name	SPEC	Material Type	Supplier	UL Number
Core	DR2W7.8*4.7(S) RCH(B=3.6)	NiZn	FengYin Electronics Corporation or Equivalent supplier	N/A
Copper Wire	2UEW-F	155°C	Elektrisola Hangzhou Co Ltd	E258243

Recommended Soldering Temperature Graph.

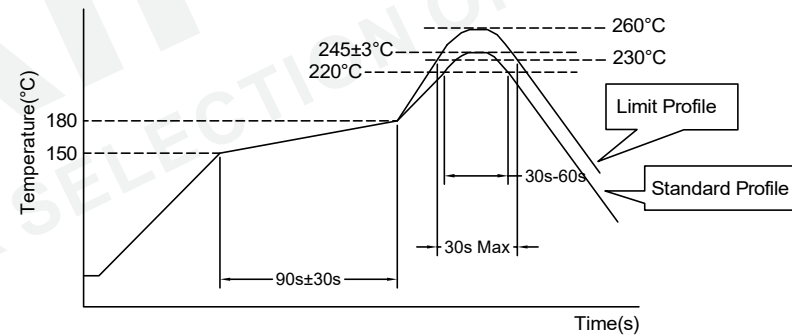

Electrical Schematic



Electrical Characteristics(@25°C)

Inductance 1KHz,0.1V S-F	DC Resistor S-F	Rated Current
3900uH±10%	18.0Ω Max	0.13A

***Operating Temperature: -40°C~+125°C
(Temperature rise included)
***Storage Temperature: -40°C~+125°C
***Storage Humidity:RH10%~70%.

	Standard Profile	Standard Profile
Pre-heating	150~180°C,90s±30s	
Heating	above 220°C,30s-60s	above 240°C,30s Max
Peak temperature	245°C±3°C	260°C,10s
Cycle of reflow	2 times	

		Tianchang Fuan Electronic Co Ltd www.fuantronics.net TEL: +86-550-7814888 FAX: +86-550-7831133		 Tolerances unless otherwise specified: (X)±0.50 (XX)±0.25 Unit of measurement: mm		Make: Qiumei.Liu Checked: Beson. zhan Approved: Anson. zhan		DRAWING TITLE DR2W7.8*4.7 POWER INDUCTORS Material Number: A330805XS310		Customer Name: Document/Rev: 00 Specification Sheet: 1 of 1 Date of Recognition: Mar./16/2020	
REV	DESCRIPTION	APPD	DATE								